



Safe ownership is your responsibility. Please thoroughly read and understand this manual before loading your firearm.

Keep firearms and ammunition away from children. Lock unloaded firearms and ammunition securely in separate locations.

This manual should always accompany your firearm and be transferred with it upon change of ownership. This is your responsibility and may protect you from future liability.

100 Springdale Road
Westfield, MA 01085

INSTRUCTION MANUAL

MSR SERIES

IMPORTANT! DO NOT ATTEMPT TO LOAD AND SHOOT YOUR RIFLE UNTIL YOU HAVE THOROUGHLY READ THIS INSTRUCTION MANUAL AND ARE FULLY FAMILIAR WITH ITS CONTENTS

For more information, please visit our web site at www.savagearms.com

Download a QR Code reader app for your Smartphone
then snap this to open Savage Arms' homepage



WWW.SAVAGEARMS.COM

Congratulations on the purchase of your new firearm. You are now part of the Savage Arms, Inc. family of quality firearms. With reasonable care, your firearm should deliver years of reliable service and perform to our “definition of accuracy”.

Safety

▲ WARNING

Risk of serious injury or death. Read and understand this manual completely before loading or using your new firearm. The Savage MSR Series incorporate features that you may not be familiar with.

- Use only new ammunition in good condition—inspect for damage before use.
- Never shoot a right-handed model left handed (or a left-handed model right handed). Doing so will put your face in the path of the forcefully-ejected case, as well as any hot gases, sparks or particles that may result from firing.
- Never disassemble your MSR beyond what’s recommended in this manual. Doing so can disable critical safety features and result in injury.
- If you hear a weak or unusual sound or if the bullet does not exit the barrel when firing, STOP immediately.

- If anything ‘feels’ or sounds different - stop - and have a qualified gunsmith take a look.
- Never fire with the UPPER RECEIVER and LOWER RECEIVER installed incorrectly. Components inside are under pressure and could come off and cause injury during firing.
- Always wear eye and ear protection when shooting. Although rare, ricochets, case failures and gas escapement can occur and cause serious eye and ear injury without proper protection.

If you do not understand any part of this manual or have questions about your firearm, contact Savage Arms at 413-568-7001 between the hours of 9:00 and 4:00 Eastern Time. This manual should always accompany your firearm and be transferred with it upon change of ownership. If lost or misplaced, download a new manual at www.savagearms.com.

Performance

The Savage Arms’ MSR Series is designed as semi-automatic firearms; one round fired per trigger pull. Always consult your local, State, and Federal guidelines to be sure the firearm, magazine, stock, etc. are lawful at your location. Savage Arms accepts no responsibility/liability should a person own or use a firearm (or accessories) that does not conform to local, State, or Federal firearm regulations.

SECTION 1: SAFETY FIRST – IT’S YOUR RESPONSIBILITY p. 2

SECTION 2: TWO POSITION SAFETY..... p. 4

SECTION 3: CALIBERS & AMMUNITION p. 5

SECTION 4: BASIC USE

- Bolt Assembly identification p. 6
- Loading p. 6
- Firing..... p. 8
- Misfire p. 8
- Unloading..... p. 8
- MSR Adjustable Gas Block..... p. 9

SECTION 5: MAINTENANCE

- Timeframe p. 9
- Disassembly p. 10
- Cleaning..... p. 13
- Oiling..... p. 14
- Reassembly..... p. 15
- MSR Precision Grip Instructions..... p. 17

SECTION 6: PARTS LIST AND DIAGRAM ... p. 17

SECTION 7: STATEMENT OF LIMITED WARRANTY..... p. 19

Although considerable time and effort was put into assuring the accuracy of the information contained herein, human errors do occur. If an error is found, please let us know. As a ‘customer driven’ company, we appreciate and encourage feedback.

SECTION 1 - SAFETY FIRST - IT'S YOUR RESPONSIBILITY

Above all – remember that a firearm is a mechanical device. It cannot think, it cannot act on its own – it only does what you make it do. A mechanical device has no way to know if your actions are safe or if they will result in injury or death – that's your part! It only takes one careless second to result in a tragedy that you will have to live with the rest of your life. Make no doubt about it, owning and/or using a firearm puts you in full control of its actions and their consequences!

Safety Alert Symbol And Signal Words

Safety alert symbol 

Indicates safety information in this manual that must be read and understood to prevent injury or death.

Signal Words:

DANGER

Indicates a hazardous situation which, if not avoided, **will** result in death or serious injury.

WARNING

Indicates a hazardous situation which, if not avoided, **could** result in death or serious injury.

CAUTION

Indicates a hazardous situation which, if not avoided, could result in minor or moderate injury.

NOTICE

Indicates a situation that could result in damage to the firearm or other property.

10 COMMANDMENTS OF SHOOTING SAFETY

The following excerpts are from SAAMI bulletin #081. The entire booklet can be obtained by contacting the NATIONAL SHOOTING SPORTS FOUNDATION.

FIREARMS SAFETY DEPENDS ON YOU!

From the time you pick up a firearm, you become part of a system over which you have complete control. You are the only part of the system that can make a gun safe – or unsafe.

You can help meet this responsibility by enrolling in hunter safety or shooter safety courses, if you have not already done so. You must constantly stress safety when handling firearms, especially to children and non-shooters. Develop safe shooting habits and remember, firearms safety is up to you. Make no mistake about it.

ALCOHOL, DRUGS AND GUNS DON'T MIX

1. ALWAYS KEEP THE MUZZLE POINTED IN A SAFE DIRECTION

This is the most basic safety rule. If everyone handled a firearm so carefully that the muzzle never pointed at something they didn't intend to shoot, there would be virtually no firearm accidents. It's as simple as that, and it's up to you.

Never point your gun at anything you do not intend to shoot. A safe direction means a direction in which a bullet cannot possibly strike anyone, taking into account possible ricochets and the fact

that bullets can penetrate walls and ceilings. Even when "dry firing" with an unloaded gun, you should never point the gun at an unintended target.

This is your responsibility, and only you can control it.

2. FIREARMS SHOULD BE UNLOADED WHEN NOT ACTUALLY IN USE

Firearms should be loaded only when you are in the field or on the target range or shooting area, ready to shoot. When not in use, firearms and ammunition should be secured in a safe place, separate from each other. It is your responsibility to prevent children and inexperienced adults from gaining access to firearms or ammunition. A loaded gun has no place in or near a vehicle or building.

Whenever you handle a firearm or hand it to someone, always open the action immediately, and visually check the chamber, receiver and magazine to be certain they do not contain any ammunition. Never assume a gun is unloaded – check for yourself! While in the field, there will be times when common sense and the basic rules of firearms safety will require you to unload your gun for maximum safety. When in doubt, unload your gun!

3. DON'T RELY ON YOUR GUN'S "SAFETY"

Treat every gun as though it can fire at any time, regardless of pressure on the TRIGGER. The "safety" on any gun is a mechanical device, which, like any such device, can become inoperable at

the worst possible time. The safety serves as a supplement to proper gun handling but cannot possibly serve as a substitute for common sense.

Never touch the trigger on a firearm until you actually intend to shoot.

Your firearm is a precision instrument. Regardless of the position of the safety, any bump strong enough to actuate the firing mechanism of a gun can cause it to fire. The only time you can be absolutely certain that a gun cannot fire is when the action is open and it is completely empty. You and the safe gun handling procedures you have learned are your gun's primary safeties.

4. BE SURE OF YOUR TARGET AND WHAT'S BEYOND IT

No one can call a bullet back. Don't shoot unless you know exactly what your bullet is going to strike. Be sure that your bullet will not injure anyone or anything beyond your target. You should keep in mind how far a bullet will travel if it misses your intended target or ricochets in another direction.

Be aware that even a .22 short bullet can travel over 1¼ miles and a high velocity cartridge, such as a 30-06, can project a bullet more than 3 miles. Shotgun pellets can travel 500 yards, and shotgun slugs have a range of over a half-mile.

5. USE CORRECT AMMUNITION

You must assume the serious responsibility of using only the correct ammunition for your firearm. Read and heed all warnings, including those that

appear in the gun's INSTRUCTION MANUAL and on the ammunition boxes. Using improper or incorrect ammunition can destroy a gun and cause serious personal injury. It only takes one cartridge of improper caliber or gauge to wreck your gun, and only a second to check each one as you load it. Be absolutely certain that the ammunition you are using matches the specifications that are contained within the gun's instruction manual and the manufacturer's markings on the firearm barrel.

Hand loaded or reloaded ammunition deviating from pressures generated by factory loads or from competent recommendations specified in reputable hand loading manuals can be dangerous, and can cause severe damage to guns and serious injury to the shooter.

Ammunition that has become very wet or has been submerged in water should be discarded in a safe manner. Do not spray oil or solvents on ammunition or place ammunition in excessively lubricated firearms.

Form the habit of examining every cartridge you put in your gun. Never use damaged, old or questionable ammunition – the money you save is not worth the risk of possible injury or a ruined gun.

Discharging firearms in poorly ventilated areas, cleaning firearms or handling ammunition may result in exposure to lead and other substances known to cause birth defects, reproductive harm and other serious physical injury. Have adequate ventilation at all times. Wash hands thoroughly after exposure.

6. IF YOUR GUN FAILS TO FIRE WHEN THE TRIGGER IS PULLED, HANDLE WITH CARE!

Occasionally, a loaded gun may not fire when the trigger is pulled. If this occurs, keep the muzzle pointed in a safe direction. Keep your face away from the breech. Then, carefully open the action, unload the firearm and dispose of the cartridge in a safe way.

Any time there is a cartridge in the chamber, your gun is loaded and ready to fire - even if you've tried to shoot and it did not go off. It could go off at any time, so you must always remember *RULE #1* and *WATCH THAT MUZZLE!*

7. ALWAYS WEAR EYE AND EAR PROTECTION WHEN SHOOTING

All shooters should wear protective shooting glasses and some form of hearing protectors while shooting. Exposure to shooting noise can damage hearing, and adequate vision protection is essential. Wearing eye protection when disassembling and cleaning any gun will also help prevent the possibility of springs, spring tensioned parts, solvents or other agents from contacting your eyes. No target shooter, plinker or hunter should ever be without them.

8. BE SURE THE BARREL IS CLEAR OF OBSTRUCTIONS BEFORE SHOOTING

Before you load your firearm, open the action and be certain that there is no cartridge in the chamber. Then glance through the barrel to be sure it is clear of any obstruction. Even a small bit of mud, snow, excess lubricating oil or grease in

the bore can cause dangerously increased pressure, causing the barrel to bulge or even burst when firing, which can cause injury to the shooter and bystanders. Make it a habit to clean the bore with a cleaning rod and patch to wipe away anti-rust compounds in the gun each time immediately before you shoot it. If the noise or recoil on firing seems weak or doesn't seem quite "right", cease firing immediately and be sure to check that no obstruction or projectile has become lodged in the barrel.

⚠️ 9. DON'T ALTER OR MODIFY YOUR GUN, AND HAVE GUNS SERVICED REGULARLY

Firearms are complicated mechanisms, which are designed by experts to function properly in their original condition. Any alteration or change (other than adjusting the AccuTrigger) made to a firearm after manufacture can make the gun dangerous and will usually void any factory warranties. Do not jeopardize your safety or the safety of others by altering the trigger, safety or other mechanism of any firearm or allowing unqualified person's to repair or modify a gun.

Your gun is a mechanical device, which will not last forever and is subject to wear. As such, it requires periodic inspection, adjustment and service.

⚠️ 10. LEARN THE MECHANISM AND HANDLING CHARACTERISTICS OF THE FIREARM YOU ARE USING

Not all firearms are the same. Consequently, never handle any firearm without first having thoroughly familiarized yourself with the particular

type of firearm you are using, the safe gun handling rules for loading, unloading, carrying and handling that firearm, and the rules of safe gun handling in general. Locate the firearm's mechanical safety device and get familiar with the feel and "on/off" positions.

You should always read and refer to the INSTRUCTION MANUAL you received with your gun, or if you have misplaced the manual, simply contact the manufacturer for a free copy.

Having a gun in your possession is a full-time job. You cannot guess; you cannot forget. You must know how to use, handle, and store your firearm safely. Do not use any firearm without having a complete understanding of its particular characteristics and safe use. There is no such thing as a foolproof gun.

SECTION 2 – TWO POSITION SAFETY

⚠️ WARNING

Accidental discharge can cause serious injury or death. Always keep the safety on and your finger off the trigger until you have clearly identified your target, lined up your sights on the intended target and verified that the backstop is clear. Always store and transport your firearm with:

- the magazine and chamber UNLOADED
- the child safe lock properly installed
- the safety ON

The SAFETY on your Savage MSR Series firearm has two positions:

1. **FULL SAFE** – If the action has been cocked (CHARGING HANDLE pulled fully rearward and then allowed to snap forward), the SAFETY BUTTON (sometimes referred to as a 'selector switch') can be rotated horizontal to the 9 o'clock position, pointing to the engraved (see FIGURE 1).



- In the FULL SAFE position, the TRIGGER is blocked from releasing the hammer and striking the firing pin.
- Always keep the SAFETY in the FULL SAFE position when there is live ammunition in either the MAGAZINE and/or chamber.



FIGURE 1

2. **SAFETY OFF/READY TO FIRE** – rotate the SAFETY BUTTON vertically to the 12 o'clock position, pointing to the engraved (see FIGURE 2).



FIGURE 2

- In the SAFETY OFF – READY TO FIRE position, the hammer will strike the firing pin when cocked and the TRIGGER pulled.

- Only move the Safety to the SAFETY OFF – READY TO FIRE position when you have clearly identified your target, lined up your sights on the intended target and verified that the backstop is clear.

SECTION 3 – CALIBERS & AMMUNITION

▲ WARNING

Each model of firearm in the Savage Arms MSR series is chambered and marked for a specific cartridge. Always verify each cartridge you load is the same caliber clearly marked on the barrel of your firearm. Remember, it only takes one cartridge of incorrect ammunition to cause personal injury and/or damage to your firearm.

Using improper or damaged ammunition can cause serious injury or gun damage.

- Always inspect your ammunition before using it. Never use damaged, corroded/stained, old or questionable ammunition. The money you save is not worth the risk of possible injury or a damaged gun.
- If you hear a weak or unusual sound or if the bullet does not exit the barrel when firing, STOP immediately. Put the safety on, unload the firearm, disassemble (as detailed in SECTION 5), and check the barrel for any obstructions.
- Use only the type of ammunition that matches what is marked on the barrel. For more information, visit the SAAMI webpage:

“UNSAFE FIREARM-AMMUNITION COMBINATIONS”

- Use only new ammunition manufactured to SAAMI/ANSI/MIL-SPEC standards. Any other ammunition including reloaded, hand loaded, and remanufactured ammunition can cause gun damage or personal injury, and will void the warranty.
- Routinely inspect the case head, primer, and body of fired brass for any signs of unusual bulging or rupturing. If you find anything out of the ordinary, discontinue use immediately and call Savage Arms at 413-568-7001 (9:00 AM and 4:00 PM Eastern Time) or a qualified gunsmith.

Performance will vary based on brand/type of ammunition, individual characteristics of the firearm, and/or shooting conditions. Bullet specifications and trajectories are available directly from the ammunition manufacturer.

CALIBER	BULLET WEIGHT (GRAINS)
223 REM	FEDERAL GOLD MEDAL 69 GRAIN BTHP
5.56MM	FEDERAL PREMIUM AMERICAN EAGLE 55 GRAIN FMJ
6.5 CREEDMOOR	HORNADY 140 GRAIN ELD-M
308 WIN	FEDERAL GOLD MEDAL 168 GRAIN BTHP

SECTION 4 – BASIC USE

BOLT ASSEMBLY IDENTIFICATION

To verify that the BOLT ASSEMBLY in your firearm is factory original, the four digits engraved should match the last four digits of the serial number engraved on the LOWER RECEIVER. The CHARGING HANDLE will need to be pulled slightly rearward in order to view the digits through the MAGAZINE WELL (see FIGURE 3).



FIGURE 3

⚠ WARNING

Savage Arms is not responsible/liable for any direct or consequential injuries or damages resulting from a firearm that has been modified or components changed.

LOADING

⚠ WARNING

Accidental discharge can cause serious injury or death. Never load or bring a loaded firearm into a

car, house or structure. Always keep the safety on and your finger off the trigger until you have clearly identified your target, lined up your sights on the intended target and verified that the backstop is clear.

⚠ WARNING

A barrel obstruction can cause excessive pressure upon firing and result in gun damage or personal injury to you or a bystander. Before loading and with the safety on, always inspect the barrel visually and with a cleaning rod for any signs of snow, mud, sticks, brush, leaves, debris, cleaning brushes, bullets or other obstructions. Never fire with the muzzle underwater or otherwise obstructed.

1. With one hand ready to catch the MAGAZINE, use the other hand to support the firearm and depress the MAGAZINE RELEASE BUTTON, ejecting the MAGAZINE into your hand (see FIGURE 4).



FIGURE 4

2. With the muzzle pointed in a safe direction and your finger off the TRIGGER, slowly pull the CHARGING HANDLE fully rearward.
3. Press the lower portion of the BOLT RELEASE (see FIGURE 5) while slowly allowing the bolt to move forward to lock the bolt open (see FIGURE 6).



FIGURE 5



FIGURE 6

⚠ CAUTION

The BOLT can forcefully slam shut unexpectedly. Keep your fingers out of the action at all times.

4. Ensure the SAFETY BUTTON is horizontal, pointing to the 9 o'clock position (see FIGURE 1); FULL SAFE.
5. Look to be sure there is no cartridge in the chamber.
6. Load the correct cartridge type (see AMMUNITION section above) into the MAGAZINE by pressing downward on the cartridge rim and sliding under the MAGAZINE lips (see FIGURE 7) until the case head is fully seated to the rear.



FIGURE 7

7. Insert the MAGAZINE into the MAGAZINE WELL, pressing upward until the latch snaps into position and is fully engaged. Try to pull the MAGAZINE downward to assure it is locked into position.
8. With your hand clear of the ejection port, press the top of the BOLT RELEASE (see FIGURE 5), allowing the BOLT to slam forward.

9. When equipped, bump the FORWARD ASSIST to ensure the BOLT is fully locked forward (see FIGURE 8).



FIGURE 8

⚠ WARNING

Once the bolt has closed, a live round will be in the chamber and may discharge if handled improperly.

⚠ WARNING

Do not load a cartridge through the ejection port. Doing so increases the chance of an unintended discharge or out of battery firing due to a slam or pinch fire, which can result in personal injury or death. Always use the magazine for loading a cartridge into the chamber.

⚠ WARNING

Loading a cartridge into a hot chamber may make it detonate unexpectedly. When in doubt, let the firearm cool down.

FIRING

▲ WARNING

Always wear eye and ear protection when shooting. Although rare, ricochets, case failures and gas escapement can occur and cause serious eye or ear injury without proper protection.

▲ WARNING

Do not shoot with missing, broken or altered components. Doing so can affect the safe and proper function of your firearm, and result in personal injury and gun damage.

▲ WARNING

Always keep the safety on and your finger off the trigger until you have clearly identified your target, lined up your sights on the intended target and verified that the backstop is clear.

▲ WARNING

Never shoot a right-handed model left handed (or a left-handed model right handed). Doing so will put your face in the path of the forcefully-ejected case, as well as any hot gases, sparks or particles that may result from firing.

▲ CAUTION

Assure the CHARGING HANDLE is fully forward, locked into the rear of the UPPER RECEIVER (see FIGURE 1). If not fully locked into position, it may move rearward from the recoil of firing, striking the shooter's face.

▲ CAUTION

When firing, always keep your hand and head away from the ejection port and bolt handle (if so equipped). Moving parts, escaping gas or other debris can escape and cause burns or cuts during normal operation or in the unlikely event of a case failure.

1. Pull the firearm STOCK firmly into your shoulder. After confirming your target and a safe backstop, move the SAFETY vertically to the 12 o'clock position – SAFETY OFF – READY TO FIRE position (see FIGURE 2).
2. Place your finger in the TRIGGER GUARD and when you are on target, squeeze the TRIGGER slowly. After each shot, the rifle will automatically cycle the BOLT and load a new cartridge into the chamber.

▲ WARNING

When shooting, your finger must hold the trigger rearward until the action has cycled and the BOLT has locked forward.

▲ WARNING

Never assume a MAGAZINE is empty, even if you hear a 'click' when the trigger is pulled.

MISFIRE

▲ WARNING

If a cartridge fails to fire after pulling the trigger, keep the muzzle pointed in a safe direction at all

times. If you have been shooting for a while and the barrel is hot, remove the magazine immediately, avoid exposure to the breech, and unload as directed below.

1. With the muzzle pointed in a safe direction and your finger off the TRIGGER, slowly pull the CHARGING HANDLE fully rearward, ejecting the misfired cartridge from the chamber.
2. Press the lower portion of the BOLT RELEASE while slowly allowing the bolt to move forward to lock the bolt open (see FIGURE 5).
3. Rotate the SAFETY BUTTON to the 9 o'clock position – FULL SAFE – as shown in FIGURE 1.
4. Retrieve the ejected misfired cartridge and dispose of it properly.
5. If the misfired cartridge remains in the chamber, follow the DISASSEMBLY procedure in SECTION 5.

UNLOADING

1. Rotate the SAFETY BUTTON to the 9 o'clock position – FULL SAFE.
2. With the muzzle pointed in a safe direction, press the MAGAZINE RELEASE BUTTON and remove it from the firearm.
3. With the muzzle still pointed in a safe direction

and your finger off the TRIGGER, slowly pull the CHARGING HANDLE fully rearward.

4. Press the lower portion of the BOLT RELEASE while slowly allowing the bolt to move forward to lock the bolt open.
5. Look in the chamber to ensure it is empty. Do not assume!
6. Look down into the MAGAZINE WELL to be sure it is empty.
7. Verify the MAGAZINE is empty.

MSR ADJUSTABLE GAS BLOCK

Certain Savage MSR models come equipped with an ADJUSTABLE GAS BLOCK. This feature allows the shooter to 'tune' the gas system on their MSR for optimal cycling performance based on the ammunition they choose.

PRIOR TO ANY ADJUSTMENT – READ AND UNDERSTAND THE INSTRUCTION MANUAL. BE SURE THE FIREARM IS UNLOADED AND THE MUZZLE POINTED IN A SAFE DIRECTION. THIS IS YOUR RESPONSIBILITY AND ONLY YOU ARE ACCOUNTABLE IF YOU DON'T.

1. To decrease the gas flow, turn the ADJUSTING SCREW (see FIGURE 9) counter-clockwise when you are in a shooting position, behind the firearm. In FIGURE 9, the screw should be turned away from you. The location of your gas

block may be located either inside the handguard (as shown in FIGURE 9) or at the forward end of the handguard, depending on model.



FIGURE 9

2. If you begin to experience cycling problems, turn the ADJUSTMENT SCREW in the opposite direction 1 click at a time until optimal ejection occurs.

OPTIMAL CYCLING PERFORMANCE WILL RESULT IN THE EJECTION PATH OF A FIRED CASE ROUGHLY BETWEEN 1 O'CLOCK AND 3 O'CLOCK.

FOR QUESTIONS OR MORE INFORMATION, PLEASE VISIT www.savagearms.com OR CONTACT TECHNICAL SERVICES AT 1-800-370-0708

SECTION 5 – MAINTENANCE

⚠ WARNING

Ensure the gun is unloaded and the SAFETY is on before disassembling or cleaning in any way. Never attempt to disassemble, clean, or oil a loaded firearm. Look and feel! Be sure the chamber and magazine are completely empty – do not assume!

⚠ WARNING

Savage Arms is not responsible for any direct or consequential injuries or damages resulting from a firearm that has been modified or components changed.

TIMEFRAME

Cartridges can leave unburnt powder, soot, bullet lube, and other contaminants (to name a few) in the receiver, chamber, bolt carrier, and/or barrel causing unreliable function. In addition, like any mechanical device your gun will not last forever and is subject to wear. When something does not sound, feel, or look right, seek the advice of a professional gunsmith immediately. Never take a chance. As with any precision tuned mechanical device, periodic inspection/maintenance is required – and your responsibility.

It is difficult to establish a time period or number of rounds as the basis for when a firearm should be examined, cleaned, and thoroughly inspected. Different shooting conditions, weather patterns, and types of ammunition, to list a few, all play a significant role in answering the questions 'when'

and 'how often'. As a general rule, 'more often' is much safer than 'not enough'. We recommend performing these basic procedures WITH AN UNLOADED FIREARM before every shooting session and cleaning after every use.

- Carefully examine the STOCK and other external components for signs of damage and assure it functions properly.
- Check the SCOPE and RINGS for tightness.
- Function the CHARGING HANDLE making sure that it cycles the BOLT without binding.
- Verify the DISCONNECTOR is functional by dry firing and continue holding the TRIGGER, cycle the CHARGING HANDLE, then release the TRIGGER. A 'click' should be heard. Pull the trigger again and the firearm should dry fire.
- With the BOLT CARRIER removed (see the disassembly instructions below), look down the barrel to be sure it is clear of any obstructions. There should be no signs of damage (nicks, scratches, etc.), rust, or pitting.
- While disassembled, inspect the inside of the RECEIVERS, BOLT ASSEMBLY, BOLT CARRIER, and other components for signs of damage, excessive wear, excessive firing residue, or missing components.

WHO SHOULD DO THE CHECKING: As the owner – or user – it is your primary responsibility to assure the firearm is safe prior to using it.

Although we know its condition when it leaves the factory, we have no control or insight as to what has or has not been done once it leaves our hands.

After reading and understanding this INSTRUCTION MANUAL – and prior to loading with live ammunition – you should be very familiar and capable of handling the items noted above. In depth mechanical issues or questions as well as periodic examinations should be referred to a qualified gunsmith or Savage Arms Service Department.

DISASSEMBLY

▲ CAUTION

Parts are under tension. Keep your fingers and eyes away from springs and moving parts and always wear eye protection during disassembly and cleaning.

▲ CAUTION

Always control the movement of the UPPER RECEIVER and LOWER RECEIVER, never allowing them to forcibly contact each other.

1. After confirming the firearm is unloaded (as detailed in SECTION 4) and the SAFETY is on, close the BOLT.
2. Push the TAKEDOWN PIN to the right (it is captivated so that it won't come out completely – see FIGURE 10) so the UPPER RECEIVER can be rotated away from the LOWER

RECEIVER.



FIGURE 10

3. Push the PIVOT PIN to the right (it is captivated so that it won't come out completely – see FIGURE 11) so the UPPER RECEIVER can be separated from the LOWER RECEIVER (see FIGURE 12).



FIGURE 11



FIGURE 12



FIGURE 14



FIGURE 16

4. Pull back on the CHARGING HANDLE approximately half way.
5. Remove the BOLT CARRIER from the UPPER RECEIVER (see FIGURE 13).

NOTICE

For models incorporating a SIDE CHARGING HANDLE (see FIGURE 15), follow steps 7 through 12. For models without a SIDE CHARGING HANDLE, please skip down to step 13.

8. Using the straight end of the Allen wrench, push the SIDE CHARGING HANDLE HINGE PIN out (see FIGURE 17).



FIGURE 13

6. Push down on the CHARGING HANDLE to disengage it from the slot (see FIGURE 14) and then remove it from the UPPER RECEIVER.



FIGURE 15

7. Using a 5/64" Allen wrench, remove the SIDE CHARGING HANDLE SET SCREW (see FIGURE 16).



FIGURE 17

9. Remove the SIDE COCKING HANDLE being careful not to lose the HINGE PIN or SET SCREW.
10. Using a 1/8" Allen wrench, remove the SIDE CHARGER FASTENER (see FIGURE 18).



FIGURE 18



FIGURE 20



FIGURE 22

11. Remove the PULL BAR by pulling it straight out of the SIDE CHARGER SLIDE BAR (see FIGURE 19). It may be necessary to push it gently from inside the RECEIVER to help in its removal.



FIGURE 19

13. Remove the FIRING PIN RETAINING PIN from the BOLT CARRIER (see FIGURE 21).



FIGURE 21

NOTICE

Do not try to open the split end of the FIRING PIN RETAINING PIN or replace it with a standard Cotter Pin.

14. Remove the FIRING PIN from the BOLT CARRIER (see FIGURE 22).

NOTICE

The MSR-10 also has a FIRING PIN SPRING.

15. Push the BOLT HEAD rearward and rotate the CAM PIN (on all models except the AR-10) as shown in FIGURE 23.



FIGURE 23

12. Remove the SIDE CHARGER SLIDER BAR by moving it rearward and out of the RECEIVER slot (see FIGURE 20).

16. Remove the CAM PIN by pulling it straight up (see FIGURE 24).



FIGURE 24

- Grasping the BOLT ASSEMBLY firmly, pull it straight out of the BOLT CARRIER (see FIGURE 25).



FIGURE 25

- With the HAMMER still cocked, press down on the BUFFER RETAINER (see FIGURE 26) so that the BUFFER can be removed.

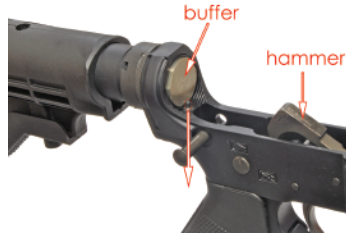

FIGURE 26

CAUTION
Parts are under tension.

- Remove the BUFFER and ACTION SPRING (see FIGURE 27), inspecting for any signs of excessive wear or deformation.



FIGURE 27

WARNING

Do not disassemble your Savage MSR series beyond this point. Disassembling anything other than what you have been instructed to do may cause damage to the firearm and/or injury to the shooter or bystander.

WARNING

Damage to or alteration of the BOLT ASSEMBLY or any component/assembly can affect the safe operation of your firearm, and result in injury and gun damage.

CLEANING

WARNING

Failure to properly maintain your firearm may lead to damage and/or serious injury to the shooter or bystander.

- Prepare an area for cleaning the firearm with a suitable surface, adequate ventilation, Hoppe's BoreSnake®, Hoppe's M-Pro 7 Tactical Cleaning Kit, and lubricant. Be sure to read and understand all of the cautions and warnings on all solvents and chemicals prior to use. Follow the manufacturer's instructions for best cleaning results.
- Disassemble as described in the applicable section above.
- Thoroughly clean the BOLT ASSEMBLY, CAM PIN, and FIRING PIN (see FIGURE 28).



FIGURE 28

- Using a Q-Tip® (or equivalent), thoroughly clean the BOLT FACE, assuring the EXTRACTOR and EJECTOR move freely (see FIGURE 29).

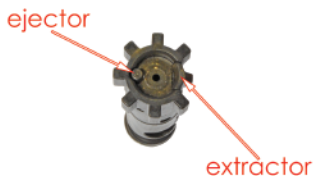

FIGURE 29

- Clean the inside of the BOLT CARRIER, removing any residue.
- With a soft cloth, clean the BUFFER and SPRING, inspecting for any signs of excessive wear or damage.

- Lay the UPPER RECEIVER horizontally on a suitable surface.
- Following the manufacturer's instructions, use the proper caliber Hoppe's BoreSnake® to thoroughly clean and lubricate the bore.
- Look down the barrel to ensure it is clear from any obstructions or damage.

⚠ WARNING

If the barrel or chamber show signs of nicks, scratches, rust, pitting or other damage, DO NOT USE. Damage can result in high pressure and cause personal injury.

⚠ WARNING

Check the bore carefully to be sure there are no obstructions (i.e. pieces of cleaning patch, a cleaning brush, cleaning rod). A barrel obstruction can cause excessive pressure upon firing and result in gun damage or personal injury to you or a bystander.

- Apply a very light coat of gun lubricant. A very thin film is sufficient protection – do not over lubricate!!!
- Clean and lightly lubricate all interior metal surfaces.
- Reassemble per the applicable section below.

- When done, always verify that the two position SAFETY is operational as explained in SECTION 2.

OILING

⚠ WARNING

Always support the HAMMER with your thumb when uncocking the action (pulling the trigger) so that it doesn't slam forward and damage the BOLT RELEASE. Since the HAMMER is under tension, be careful not to injure your thumb.

- Using lubricant, apply the lubricant in the LOWER RECEIVER areas highlighted with arrows (see Figure 30).

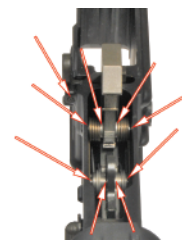

FIGURE 30

- Apply lubricant along the shafts of the TAKEDOWN PIN and PIVOT PIN.
- Apply lubricant along the whole length of the BOLT CARRIER in the areas shown (see FIGURE 31).

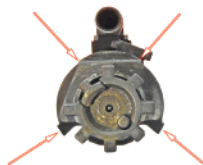

FIGURE 31



FIGURE 33



FIGURE 35

4. Liberally coat the sides of the CAM PIN (see FIGURE 32) with lubricant, being sure that some also runs down the shaft.

6. Liberally coat the sides and top surfaces of the CHARGING HANDLE with lubricant (see FIGURE 34).

2. Install the CAM PIN opposite as shown in FIGURE 24 above, positioning the EXTRACTOR and EJECTOR as shown in FIGURE 36.

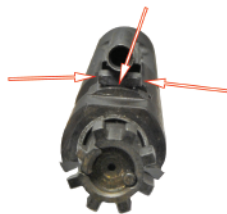

FIGURE 32



FIGURE 34

5. Apply the lubricant in the UPPER RECEIVER areas highlighted with arrows (see Figure 33).

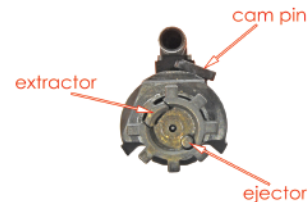

FIGURE 36

REASSEMBLY

1. Insert BOLT ASSEMBLY into the BOLT CARRIER, aligning the CAM PIN hole as shown in FIGURE 35.

NOTICE

If the CAM PIN does not go into the BOLT ASSEMBLY hole, rotate the BOLT ASSEMBLY 180° and try inserting it again.

3. Rotate the CAM PIN as shown in FIGURE 37.



FIGURE 37

4. Install the FIRING PIN as shown in FIGURE 38.



FIGURE 38

5. Install the FIRING PIN RETAINING PIN, starting from the large counterbore as shown in FIGURE 39.



FIGURE 39

NOTICE

Do not try to open the split end of the FIRING PIN RETAINING PIN or replace it with a standard Cotter Pin.

6. Grasp the face of the BOLT ASSEMBLY and pull it forward so that the CAM PIN is positioned as shown in FIGURE 40.



FIGURE 40

7. Push the ACTION SPRING and BUFFER back in to the BUTT STOCK until they snap behind the BUFFER RETAINER (opposite as shown in FIGURE 27 above).

CAUTION

Parts are under tension.

8. Turn the UPPER RECEIVER upside down and insert the CHARGING HANDLE aligning the notches as shown in FIGURE 41

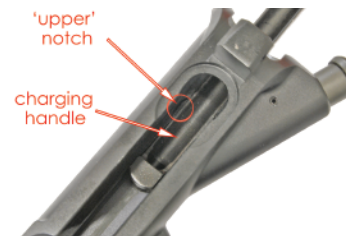

FIGURE 41

9. Insert the GAS KEY into the CHARGING HANDLE (see FIGURE 42).

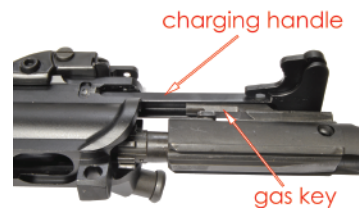

FIGURE 42

10. Carefully slide the CHARGING HANDLE and BOLT CARRIER fully forward into the UPPER RECEIVER (see FIGURE 43).



FIGURE 43

11. Position the UPPER RECEIVER and LOWER RECEIVER so that the PIVOT PIN can be pushed completely to the left, joining the two halves (opposite as shown in FIGURE 10 above).
12. Rotate the UPPER RECEIVER and LOWER RECEIVER so that the TAKEDOWN PIN can be pushed completely to the left (opposite as shown in FIGURE 9 above).

▲ WARNING

Ensure the PIVOT PIN and TAKEDOWN PIN are seated properly and locked into position (sides flush with the receiver). An unsecured UPPER RECEIVER and LOWER RECEIVER may separate during firing and injure the shooter.

13. Verify the DISCONNECTOR is functional by dry firing and continue holding the TRIGGER, cycle the CHARGING HANDLE, then release the TRIGGER. A 'click' should be heard. Pull the trigger again and the firearm should dry fire.
14. Cycle the action and engage the SAFETY several times to assure that it is functioning

properly prior to loading. If the action does not cycle properly or the bolt binds, review the steps above. If there continues to be a problem, call Savage Arms Service Department for assistance (413-568-7001 between 9:00 AM and 4:00 PM Eastern Time). Never take a chance with something that you are unsure of ... always ask a professional.

MSR PRECISION GRIP INSTRUCTIONS

PRIOR TO ANY ADJUSTMENT – READ AND UNDERSTAND THE INSTRUCTION MANUAL. BE SURE THE FIREARM IS UNLOADED AND THE MUZZLE POINTED IN A SAFE DIRECTION. THIS IS YOUR RESPONSIBILITY AND ONLY YOU ARE ACCOUNTABLE IF YOU DON'T.

To rotate the grip angle, rest butt stock on a steady surface. Pull straight down on lower grip section only and rotate 180 degrees. Allow lower grip section to snap into place once it is rotated completely.



FOR QUESTIONS OR MORE INFORMATION, PLEASE VISIT www.savagearms.com OR CONTACT TECHNICAL SERVICES AT 1-800-370-0708

SECTION 6 – PARTS LIST AND DIAGRAM

As a 'customer driven' company, some parts may now be ordered directly from our web site (WWW.SAVAGEARMS.COM) within the continental United States, twenty four hours a day. All you will need is the serial number and credit card. For accessing our part finder via your Smartphone, please use the QR Code below. Should you not have access to our web site, parts can be ordered directly from Savage Arms (413-568-7001 between the hours of 9:00 AM and 4:00 PM Eastern Time). There is a minimum order and please allow 2 weeks for delivery. Only the parts indicated may be purchased by an individual. All other parts/subassemblies are either 'factory fit' or available to qualified gunsmiths only.

Please be advised that some parts may require fitting. Savage Arms bears no responsibility for the function or performance of any firearm that has been repaired or modified by other than Savage Arms Service Department. As such, Savage Arms accepts no responsibility/liability for any direct and/or consequential damage and/or injury resulting from the use of a firearm repaired or modified by other than the Savage Arms Service Department.

Some parts are under tension – watch your fingers and always wear eye protection.

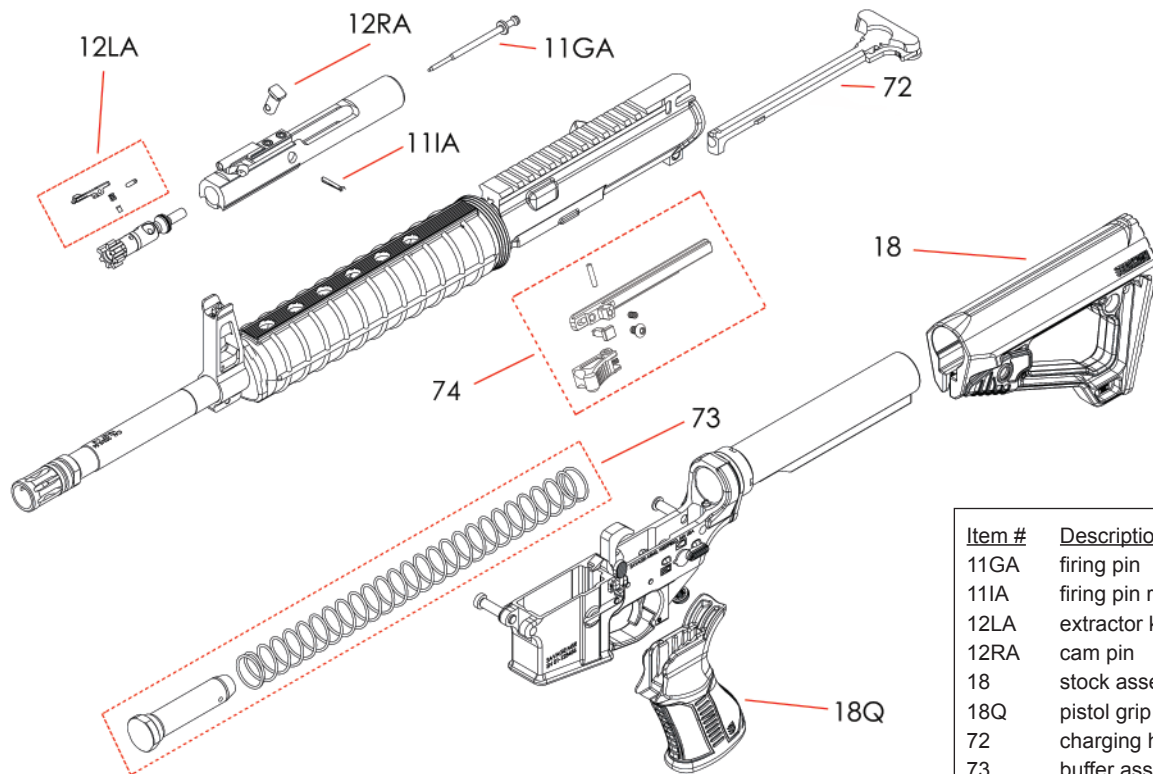

<u>Item #</u>	<u>Description</u>
11GA	firing pin
11A	firing pin retaining pin
12LA	extractor kit
12RA	cam pin
18	stock assembly
18Q	pistol grip
72	charging handle
73	buffer assembly
74	side charging handle assembly

SECTION 9 – STATEMENT OF LIMITED WARRANTY

For your convenience, registration may now be completed directly from our web site (WWW.SAVAGEARMS.COM) twenty four hours a day. Should you not have access to our web site, please complete the WARRANTY REGISTRATION CARD and return it to Savage Arms, Inc. within ten (10) days from the date of purchase.

WHO IS COVERED?

- The original owner (with proof of purchase).

WHAT IS COVERED?

- Any defect in materials or workmanship (performed by Savage Arms) encountered during normal use.

HOW LONG IS THE WARRANTY PERIOD?

- One (1) year from the date of purchase.

WHAT IS NOT COVERED?

DAMAGE TO THE FIREARM CAUSED BY:

- Improper maintenance or failure to provide proper care and maintenance in accordance with this manual.
- Alterations/modifications performed without the written authorization of Savage Arms Service Department.
- Normal wear; tear; and/or corrosion.
- Accidental discharge, careless handling, and/or misuse.
- Barrel obstructions.
- Use of incorrect ammunition or ammunition

other than new/or not loaded to SAAMI specification.

- Failure to follow the instructions and warnings in this manual.

EXCLUSIONS AND LIMITATIONS:

ANY WARRANTIES IMPLIED BY LAW SHALL IN NO EVENT EXTEND BEYOND THE DURATION OF THIS EXPRESS WARRANTY. Some States do not allow limitations on how long an implied warranty lasts, so the above limitation may not apply to you. REPAIR OR REPLACEMENT AS PROVIDED HEREIN IS YOUR EXCLUSIVE REMEDY FOR ANY DEFECTIVE PRODUCT. IN NO EVENT SHALL WE BE LIABLE FOR ANY SPECIAL, INCIDENTAL OR CONSEQUENTIAL DAMAGES OF ANY KIND ARISING OUT OF THE PURCHASE OR USE OF THIS PRODUCT, WHETHER BASED UPON CONTRACT, TORT, STATUTE OR OTHERWISE. Some states do not allow the exclusion or limitation of incidental or consequential damages, so the above limitation or exclusion may not apply to you. This warranty gives you specific legal rights, and you may also have other rights which vary from State to State.

RETURNING A FIREARM:

All firearms within the continental United States should be sent to Savage Arms at the owner's expense. Warranty repairs will be returned to the owner at Savage Arms' expense.

Firearms owned by individuals in Canada cannot be returned directly to Savage Arms due to import/export laws. If your firearm requires

warranty service, please contact one of the Savage Arms Warranty Stations listed on our website (WWW.SAVAGEARMS.COM) or call our Customer Service number listed above.

For WARRANTY claims, proof of purchase must accompany the firearm.

It is a violation of Federal Law to ship a firearm with live ammunition either in the MAGAZINE, chamber, or placed in the box. For the safety of all involved, please be sure there is no ammunition in either the chamber, MAGAZINE, or box.

Savage Arms, Inc, is not responsible for the loss or damage to any accessories shipped with the firearm.

If there is a question whether the firearm should be returned or parts could be purchased, please call 413-568-7001 between 9:00 AM and 4:00 PM Eastern Time and ask for the Service/Warranty Department.

All firearms are to be sent to Savage Arms at the owner's expense. Warranty repairs will be returned to the owner at Savage Arms' expense.

1. Pack the firearm in its original box if possible. If a similar suitable box is used, care should be taken to protect the barrel/muzzle from breaking through. Always pack with the assumption that the firearm will undergo rough handling during transit to Savage Arms.

2. Enclose a brief note including:
 - name, address and phone number of the sender
 - serial number of the firearm
 - description of the problem you are having
 - bullet weight, bullet type, and manufacturer of the ammunition you are using
 - any other information which you feel may be helpful.

3. Return to:
 - Savage Arms
 - 100 Springdale Road
 - Westfield, MA 01085
 - Attn: Service Department

4. If there will be a charge involved for the repair, a quote will be sent within fourteen (14) working days.
 - If there is no response from the quote within thirty (30) days, the firearm will be returned COD (\$20.00 Shipping/Handling).

Firearms will be repaired typically 3 weeks after receipt of payment in the order they were received.



**You're proud to
shoot a Savage—
so show it!**

Choose from a wide selection of Savage t-shirts, hats and other great apparel and gear at store.savagearms.com.

Don't miss out—check back often for the latest designs.

Receive **10% OFF**
your first order!

Code will be emailed to you after you complete your online warranty registration.

www.store.savagearms.com



For more than a century, Savage Arms has carefully crafted the world's most accurate, consistent and reliable firearms. We're proud to stand behind our products with a 1-year warranty, and we're willing to do whatever it takes to ensure your Savage performs as it should.

To take full advantage of this warranty, please register your firearm at www.savagearms.com/warranty.

For new product purchases, please complete the online warranty registration within 10 days from the date of purchase.

Statement of Limited Warranty

Who is covered?

The original owner (with proof of purchase).

How long is the warranty period?

One (1) year from the date of purchase.

What is covered?

Any defect in materials or workmanship (performed by Savage Arms) encountered during normal use.

What is NOT covered?

Personal injury, property damage, and/or damage to the firearm caused by:

- Improper maintenance or negligence to provide proper care and maintenance.
- Alterations/modifications performed without the written authorization of the Savage Arms Service Department.
- Normal wear, tear and/or corrosion.
- Accidental discharge, careless handling and/or misuse.
- Barrel obstructions.

Exclusions and Limitations

This warranty and the remedies set forth herein are exclusive and take the place of all other expressed or implied WARRANTIES (including any implied warranty of merchantability or fitness for any particular purpose which are disclaimed). No other representations or claims of any nature shall be binding on or obligate Savage Arms. Savage Arms excludes any incidental and consequential damages under this warranty. Some states do not allow exclusions or limitations on how long an implied warranty lasts, so the above limitations may not apply to you.

This warranty gives you specific legal rights. You may have other rights, which will vary from state to state.



WARNING

Firearms must be handled responsibly and securely stored to prevent access by children and other unauthorized users. California has strict laws pertaining to firearms, and you may be fined or imprisoned if you fail to comply with them. Visit the website of the California Attorney General at <https://oag.ca.gov/firearms> for information on firearm laws applicable to you and how you can comply.

Prevent child access by always keeping guns locked away and unloaded when not in use. If you keep a loaded firearm where a child obtains and improperly uses it, you may be fined or sent to prison.

If you or someone you know is contemplating suicide, please call the national suicide prevention lifeline at 1-800-273-TALK (8255).



WARNING

This product can expose you to chemicals including lead, which is known to the State of California to cause cancer and reproductive harm. For more information go to www.P65Warnings.ca.gov



ADVERTENCIA

Las armas de fuego deben ser manejadas de manera responsable y almacenadas de manera segura para evitar el acceso de niños y otros usuarios no autorizados. California tiene leyes estrictas relativas a las armas de fuego, y puede ser multado o encarcelado si no cumple con ellas. Visite el sitio web del Procurador General de California en <https://oag.ca.gov/firearms> para obtener información sobre las leyes de armas de fuego aplicables a usted y cómo puede cumplir.

Evite el acceso de los niños manteniendo siempre las armas cerradas y descargadas cuando no estén en uso. Si mantiene un arma de fuego cargada donde un niño la obtiene y la usa incorrectamente, puede ser multado o enviado a prisión.

Si usted o alguien que conoce está contemplando el suicidio, llame a la línea de vida nacional de prevención del suicidio al 1-800-273-TALK (8255).



ADVERTENCIA

Este producto puede exponerle a sustancias químicas que incluyen el plomo, que el estado de California reconoce como causante de cáncer y daños al sistema reproductivo. Para más información, visite www.P65Warnings.ca.gov



AVERTISSEMENT

Les armes à feu doivent être manipulées de manière responsable et stockées en toute sécurité pour empêcher les enfants et les autres utilisateurs non autorisés d'y accéder. La Californie a des lois strictes concernant les armes à feu et vous pouvez être condamné à une amende ou à une peine d'emprisonnement si vous ne vous y conformez pas. Visitez le site Web du procureur général de Californie à <https://oag.ca.gov/firearms> pour obtenir des informations sur les lois sur les armes à feu qui vous concernent et comment vous pouvez vous y conformer.

Empêchez l'accès des enfants en gardant toujours les pistolets sous clé et déchargés lorsqu'ils ne sont pas utilisés. Si vous gardez une arme à feu chargée là où un enfant l'obtient et l'utilise de manière inappropriée, vous pourriez être condamné à une amende ou à une peine de prison.

Si vous ou quelqu'un que vous connaissez envisagez le suicide, veuillez appeler la ligne de vie nationale pour la prévention du suicide au 1-800-273-TALK (8255).



AVERTISSEMENT

Ce produit peut exposer l'utilisateur à des produits chimiques, comme le plomb, que l'État de Californie reconnaît comme étant cancérigène et nocif pour la reproduction. Pour plus d'information, consultez le www.P65Warnings.ca.gov

 **SAVAGE ARMS®**

100 Springdale Road, Westfield, MA 01085

www.savagearms.com (800) 370-0708 (413) 568-7001

112181 (01/21) Rev. 2